



SN INTERNATIONAL LLC

Custom Neon Sign



Merry
Christmas

Neon Tube



- The appearance of PVC light strips is almost the same as that of silicone light strips. Then some supplier use PVC light strips, and PVC light strips are not safe. It has the characteristics of poor heat resistance, not environmental protection and easy to burn. That's why their price are lower.
- SN uses high quality food grade silicone light strips.



Neon Tube Details



Tidy end cap



No dark spots



Neat cut and Smooth wires

Acrylic Details



No scratch



100% clean and transparent

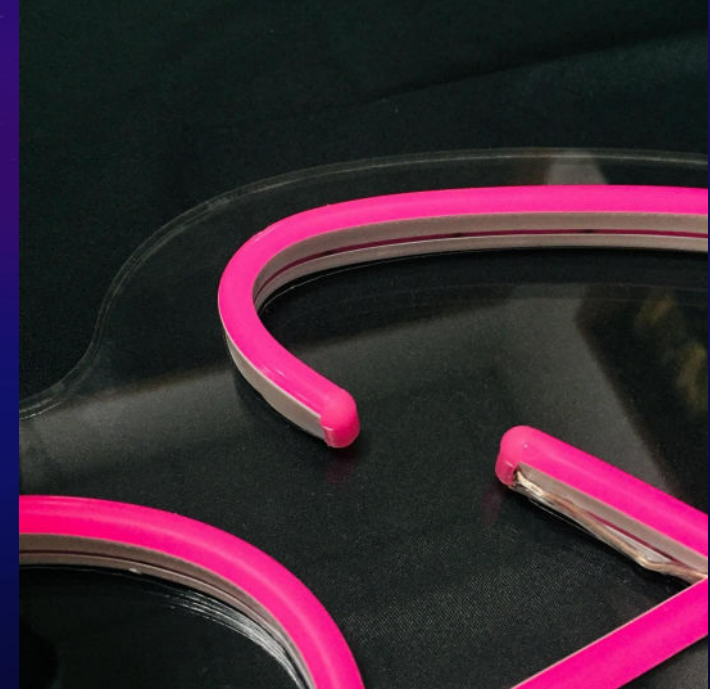

No extra glue

12V LED Neon sign



Vibe



Customization



Business



Shop



Wedding



Party

RGB LED Neon sign



1. With 1 push of a button you decide in which color you put the neon sign.

2. With the handy RGB touch remote control can choose from many different modes and let the colors smoothly or quickly fade into one another.

12V Waterproof Neon sign

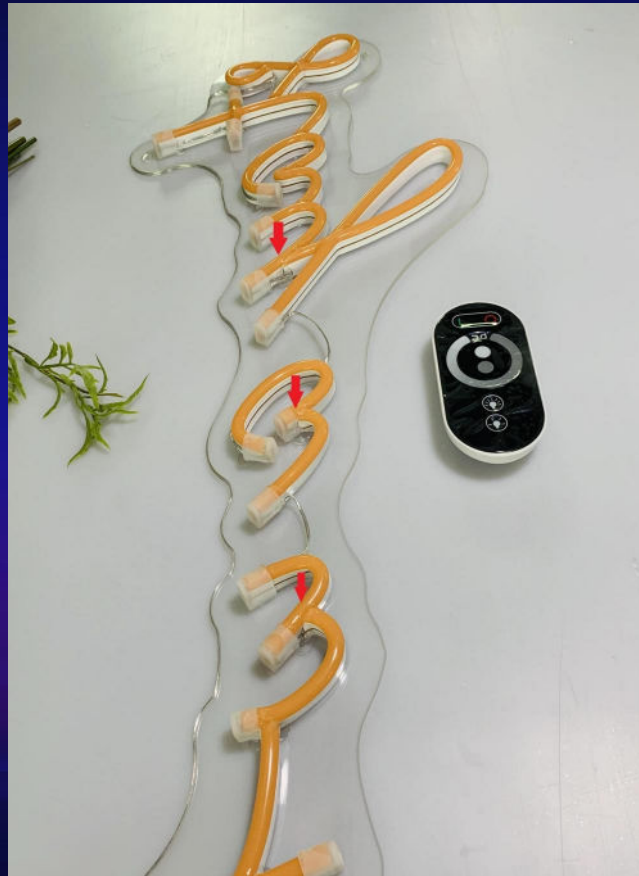

1. Exquisite workmanship, no excess glue drips onto the acrylic.

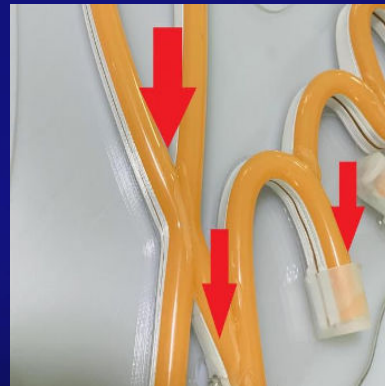

2. The end of each light strip will be equipped with an end cap to prevent water from entering to the greatest extent.

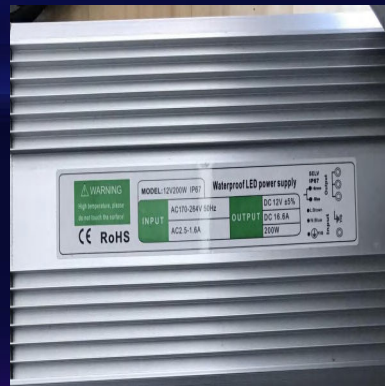

3. Every waterproof neon sign will be equipped with a waterproof power supply.

Cut to leeter flex neon sign



1. Elastic, no scratches/cracks in acrylic due to shipping.



2. Invisible acrylic, hardly see any acrylic on the front.



3. Easy to be install by 3M sticker.



LED Neon sign box



1. Widely used in shops, hotels, commercial centers, bar.
2. 100% waterproof.
3. Can stand on the table.

LED Neon sign open box



1. Widely used in shops, hotels, commercial centers, bar.
2. Can stand on the table.

UV Printing neon sign



Colorful acrylic neon sign



Black acrylic



Golden mirror acrylic

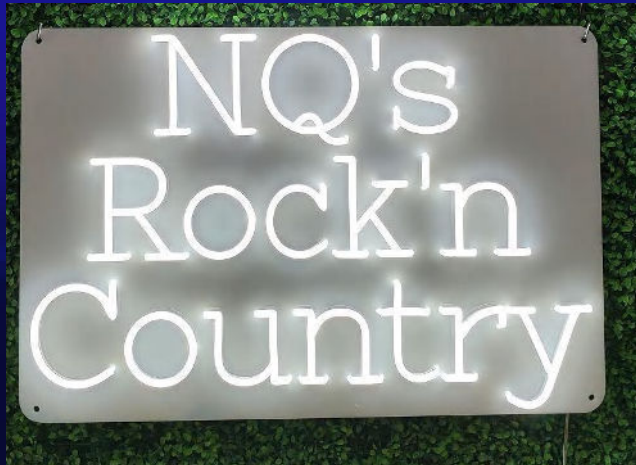

Whiter acrylic



Sliver mirror acrylic

5V LED Neon sign



1. The unit price is cheaper than 12V, and the market competitiveness is stronger



2. Low unit price.



USB



3*AA battery

3. USB interface, portable anywhere. Just need a power bank/battery box to light up

3 Gen LED neon sign

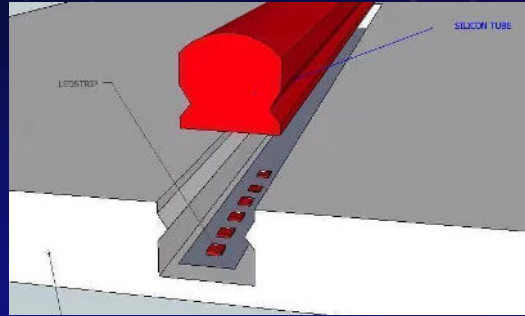

1. The chip is separated from the light strip, and the manufacturing process is simple shorter production time

2. Almost no lines can be seen on the front, smooth and neat

30% cheaper than regular neon

Alloy Neon sign (NEW)

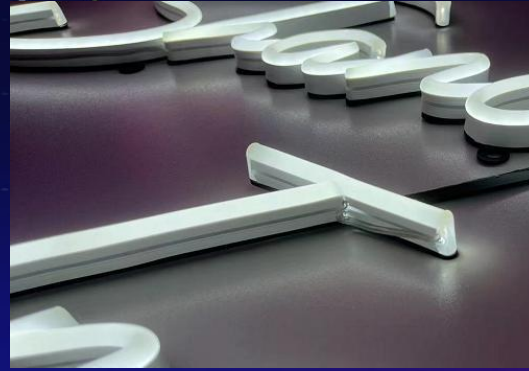

1. The back is alloy plate, tougher than regular cut to letter neon sign.



2. Alloy has good support and is not easy to bend.



3. Black alloy, looks texture.

Gradient acrylic neon sign (NEW)



Gradient acrylic:

1. Different colors from different angles.
2. The color of the acrylic will change with the color of the background.

Double sided neon sign (NEW)



Different color mirror acrylic(NEW)



Sliver silk acrylic(NEW)



- Silk-like texture
- Suitable for restaurants, weddings.

Golden silk acrylic(NEW)



- Silk-like texture.
- Suitable for restaurants, weddings.

Multilayer mirror neon sign(NEW)



Golden Multilayer mirror neon sign(NEW)



Color Board

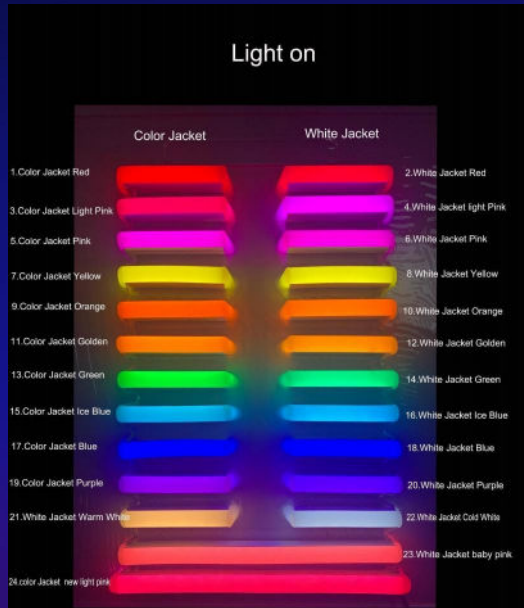

12V Color Board



5V Color Board



3 Gen 12V Color Board

Accessories



Power supply



Dimmer

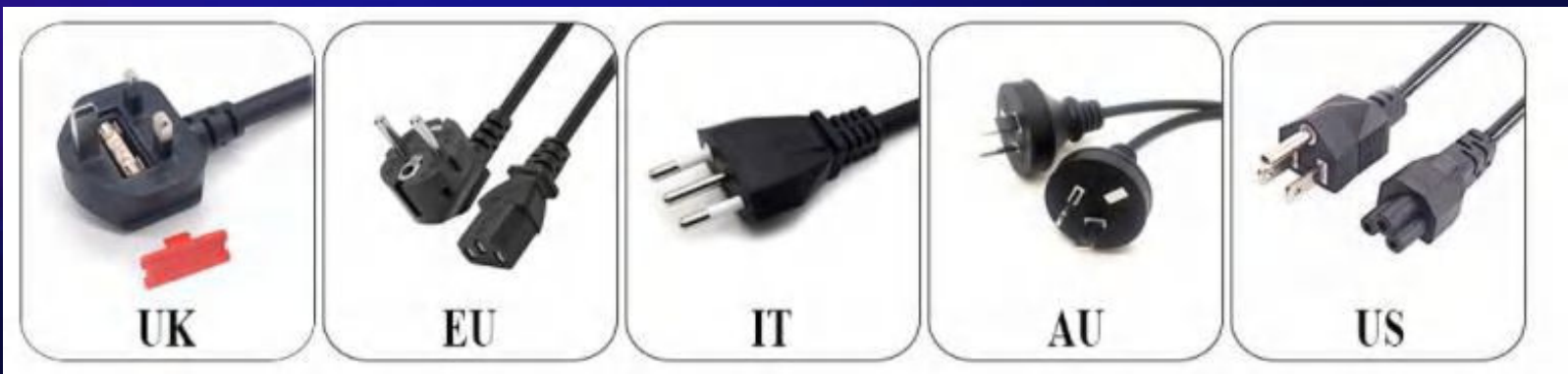

Plug

Installation method



Wire rope



Nail



Wall sticker



3M sticker

How SN produce your neon sign

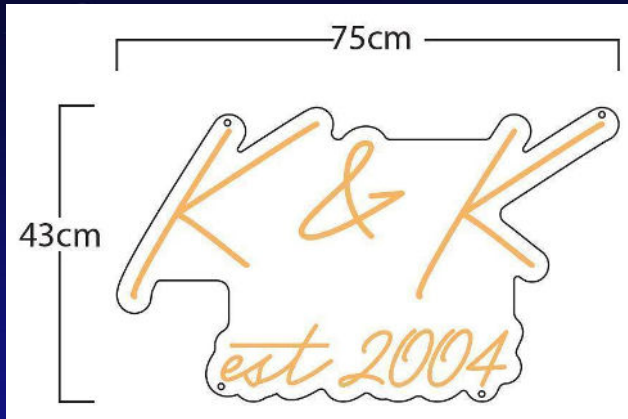

1.Design Sketch



2.Engraving acrylic

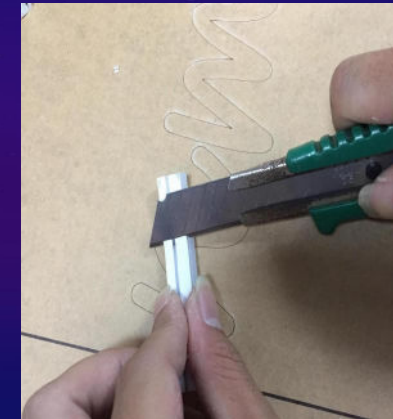

3.Cutting LED strip



6.Production is completed



5.Soldering



4.Stick the strip on Acrylic Board

Quality inspection



1. Is the design correct?
2. Is the color correct?
3. Is the shape correct?
4. Is the acrylic clean?
5. Any dark spots in the light strip?
6. Are the neat connections?
7. Is there any residue/excess glue?
8. Is the power supply overheating?
9. Is the light strip overheating?

Packaging process



Custom packaging

01 Building Brand

Help you build brand influence.

02 Distinctive packaging

Make your package stand out from others.

03 Refuse to be boring

Colorful printing can catch people's eyes.

04 Customer Experience

Exquisite packaging gives customers the feeling of opening a gift.

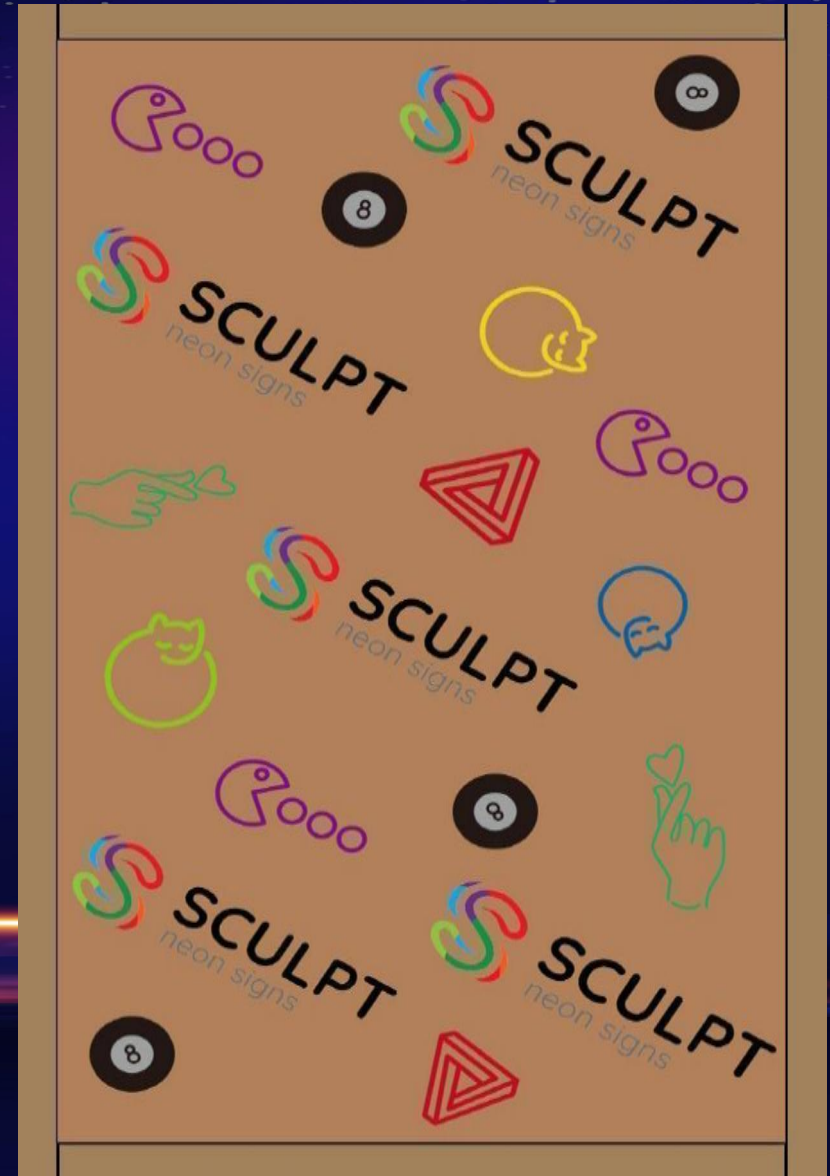



- U.S. Headquarters
6650 Rivers Ave Ste 105 #301787, North
Charleston, South Carolina 29406
- China Office
Room 1007, Hengtong Building, No. 395
Shangyuan Street, Jiangning District, Nanjing,
211100
- Email:sally@sn-intl.com
- WhatsApp:[+86-18020163117](https://wa.me/+86-18020163117)



Merry
Christmas